

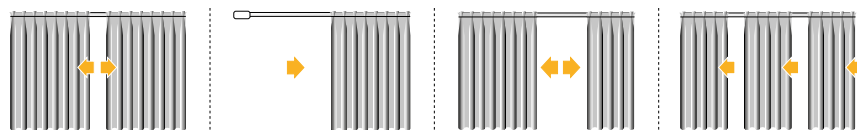

2.1.2

# Zenith 423 - Nadir 426







# Zenith 423 - Nadir 426



## CARATTERISTICHE TECNICHE - SPECIFICATIONS CARACTERÍSTICAS - CARACTERÍSTICAS - CARACTÉRISTIQUES EIGENSCHAFTEN - KARAKTERISTIEKEN - ХАРАКТЕРИСТИКИ

- Profilo in lega d'alluminio estrusa 6060 T6 UNI 8278
  - **Zenith 423:** Larghezza 12 mm; Altezza 7 mm
  - **Nadir 426:** Larghezza 13 mm; Altezza 9 mm
  - Canale di scorrimento 4,5 mm
  - Raggio di curvatura minima 423:  
curve a 90°: 6/12 cm; curve ad ampio raggio 50 cm
  - Raggio di curvatura minima 426:  
curve a 90°: 10 cm; curve ad ampio raggio 50 cm
  - Finitura superficiale:  
verniciatura poliester bianco RAL 9016  
anodizzato argento - oro
  - Accessori in acetilica autolubrificante
- 6060 T6 UNI 8278 extruded aluminium alloy track
  - **Zenith 423:** Width 12 mm; Height 7 mm
  - **Nadir 426:** Width 13 mm; Height 9 mm
  - Sliding channel 4.5 mm
  - Minimum radius of curvature 423:  
90° curves: 6/12 cm; wide radius curves: 50 cm
  - Minimum radius of curvature 426:  
90° curves: 10 cm; wide radius curves: 50 cm
  - Surface finish:  
RAL 9016 white polyester paint  
silver - gold anodised
  - Self-lubricating acetylic accessories
- Perfil en aleación de aluminio extruido 6060 T6 UNI 8278
  - **Zenith 423:** Anchura 12 mm - Altura 7 mm
  - **Nadir 426:** Anchura 13 mm - Altura 9 mm
  - Canal de deslizamiento 4,5 mm
  - Radio de curvatura mínima 423:  
curvas en 90°: 6/12 cm; curvas de amplio ángulo: 50 cm
  - Radio de curvatura mínima 426:  
curvas en 90°: 10 cm; curvas de amplio ángulo: 50 cm
  - Acabados de la superficie:  
pintura poliéster blanca RAL 9016; anodizado plata - oro
  - Accesorios de acetálico autolubricante
- Perfil de liga de aluminio extruido 6060 T6 UNI 8278
  - **Zenith 423:** Largura 12 mm; Altura 7 mm
  - **Nadir 426:** Largura 13 mm; Altura 9 mm
  - Calha de deslizamento 4,5 mm
  - Raio de curvatura mínimo 423:  
curvas de 90°: 6/12 cm; curvas de raio amplo: 50 cm
  - Raio de curvatura mínimo 426:  
curvas de 90°: 10 cm; curvas de raio amplo: 50 cm
  - Acabamento superficial:  
tinta de poliéster branca RAL 9016  
anodizado prateado - dourado
  - Acessórios de resina acetálica autolubrificante
- Profil en alliage d'aluminium extrudé 6060 T6 UNI 8278
  - **Zenith 423:** Largeur 12 mm; Hauteur 7 mm
  - **Nadir 426:** Largeur 13 mm; Hauteur 9 mm
  - Rail de coulissement 4,5 mm
  - Rayon minimum 423:  
courbes à 90°: 6/12 cm; courbes à grand rayon 50 cm
  - Rayon minimum 426:  
courbes à 90°: 10 cm; courbes à grand rayon 50 cm
  - Finition superficielle:  
peinture polyester blanc RAL 9016  
anodisé argent - or
  - Accessoires en résine d'acétal autolubrificante
- Profil aus extrudierter Alu-Legierung 6060 T6 UNI 8278
  - **Zenith 423:** Breite 12 mm; Höhe 7 mm
  - **Nadir 426:** Breite 13 mm; Höhe 9 mm
  - Laufkanal 4,5 mm
  - Kleinster Biegeradius 423:  
90°-Kurven: 6/12 cm; Kurven mit großem Radius 50 cm
  - Kleinster Biegeradius 426:  
90°-Kurven: 10 cm; Kurven mit großem Radius 50 cm
  - Oberflächen-Finish:  
Polyesterlackierung Weiß RAL 9016  
Silber, messing - eloxiert
  - Zubehör aus selbstschmierendem Acetal
- Profiel in geëxtrudeerde aluminium legering 6060 T6 UNI 8278
  - **Zenith 423:** Breedte 12 mm; hoogte 7 mm
  - **Nadir 426:** Breedte 13 mm; hoogte 9 mm
  - Glijkanaal 4,5 mm
  - 423: Minimum straal van verbuiging op 90°: 6/12 cm  
op grote straal: 50 cm
  - 426: Minimum straal van verbuiging op 90°: 10 cm  
op grote straal: 50 cm
  - Oppervlaktebehandeling:  
polyesterlak wit RAL 9016  
geanodiseerd zilver of goudkleur
  - Onderdelen in zelfsmierend acetyl
- Профиль из экструдированного алюминиевого сплава 6060 T6 UNI 8278
  - **Zenith 423:** Ширина 12 мм; Высота 7 мм
  - **Nadir 426:** Ширина 13 мм; Высота 9 мм
  - Желоб 4,5 мм
  - Минимальный радиус поворота 423:  
повороты 90°: 6/12 см; повороты с большим радиусом: 50 см
  - Минимальный радиус поворота 426:  
повороты 90°: 10 см; повороты с большим радиусом: 50 см
  - Отделка поверхности:  
полиэфирная окраска в белый цвет RAL 9016  
анодирование серебро - золото
  - Принадлежности из самосмазывающейся ацеталовой пластмассы

# Zenith 423 - Nadir 426

CURVE - BENDING - CURVAS - CURVAS  
 COURBAGE - BOGEN - BUIGEN - ИЗГИБ



art. 9864 (Sec. C)

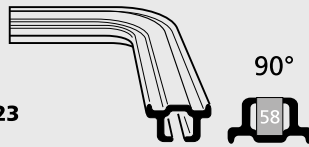

ZENITH 423

90°

58

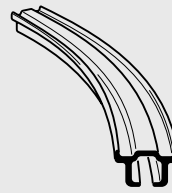

art. 9865 (Sec. C)



art. 9805 (Sec. C)

ZENITH 423



art. 9804 (Sec. C)



art. 9974 (Sec. C)



art. 9860 (Sec. C)

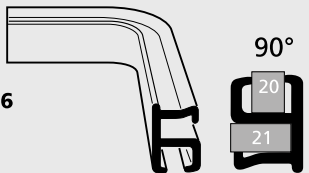

NADIR 426

90°

20

21

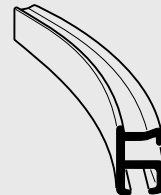

art. 9861 (Sec. C)



art. 9805 (Sec. C)

NADIR 426



art. 9804 (Sec. C)



art. 9961 (Sec. C)

ZENITH 423

INSTALLAZIONE

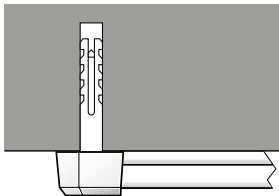

4360

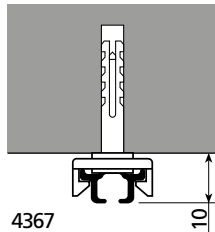

4367

10

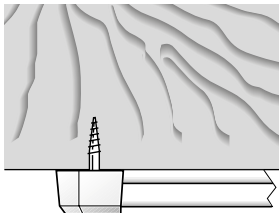

4360

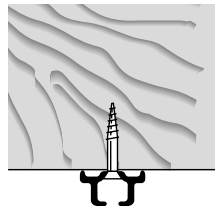

4362

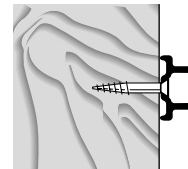

4362

INSTALLATION  
 INSTALACIÓN  
 INSTALAÇÃO  
 INSTALLATION  
 INSTALLATION  
 INSTALLATIE  
 УСТАHOВКА

NADIR 426

INSTALLAZIONE

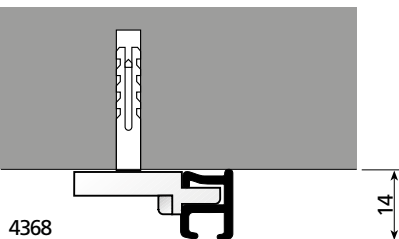

4368

14

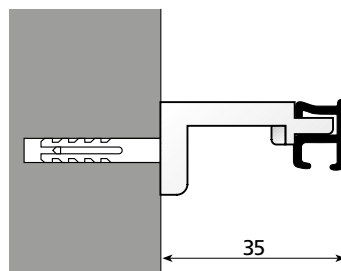

4366

35

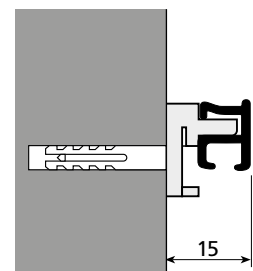

4369

15

INSTALLATION  
 INSTALACIÓN  
 INSTALAÇÃO  
 INSTALLATION  
 INSTALLATION  
 INSTALLATIE  
 УСТАHOВКА

# Zenith 423 - Nadir 426

## Zenith 423

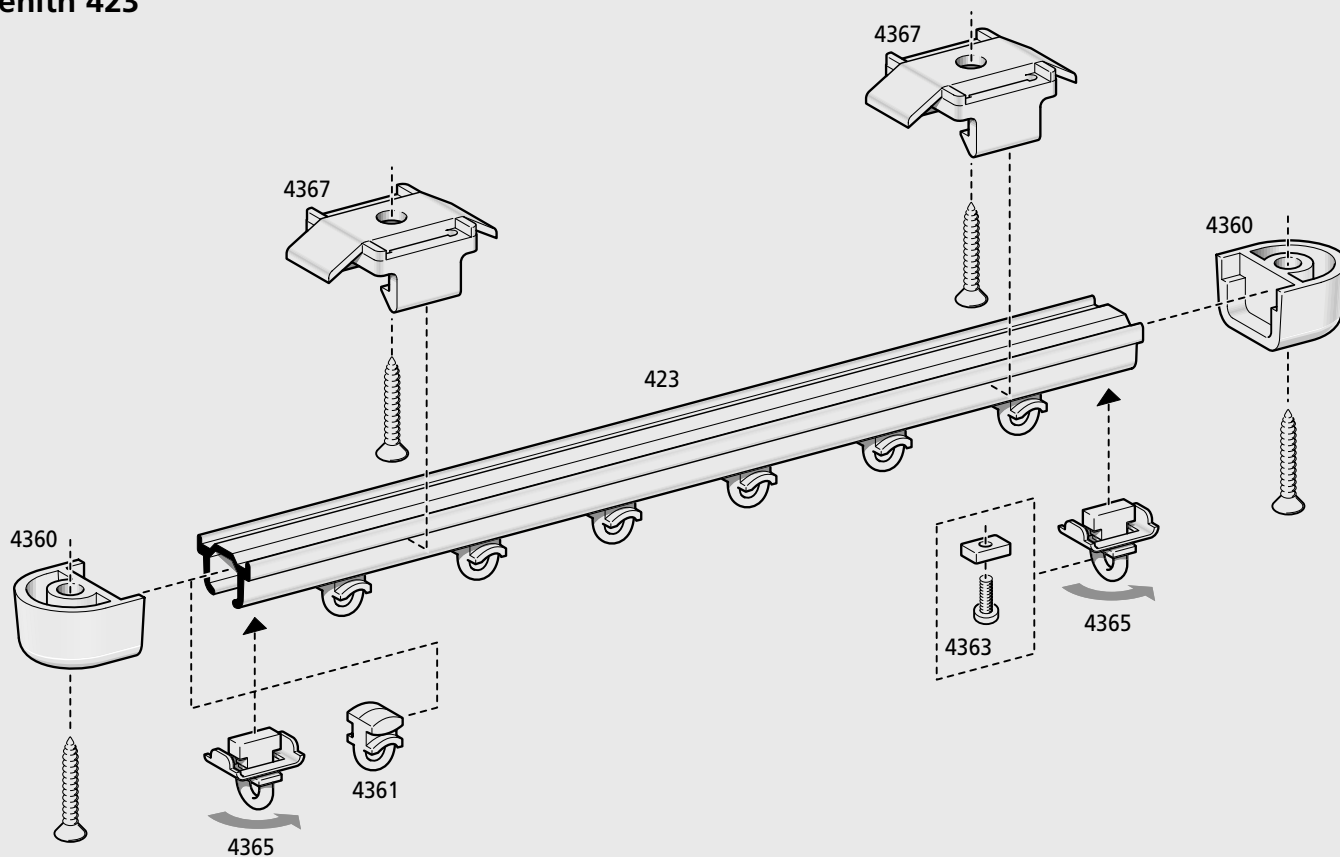

## Nadir 426

